

light source

work equipment
connected load
Power consumption
luminous flux
luminous efficacy
light distribution
colour temperature
color rendering index (CRI)
glare control
System of protection
class of protection
technology
operation
luminaire body

lamp cover
weight (net)
mains supply

design
Fastening
dimension
special features

LED
 Energy efficiency category A/A+/A++
 without
 22-26 V; DC
 approx. 6 W
 approx. 630 lm
 approx. 105 lm/W
 direct
 neutral white, approx. 5000 K
 >= 80
 screen
 IP54
 III
 switchable
 external
 aluminium/plastic, anodised; painted, aluminium coloured
 anodised
 Acrylic satine
 approx. 0.2 kg
 built-in plug
 M12-A-5
 mounted version
 bracket
 A=335mm, C=290mm, C1=320mm
 through-wired



M12-A-5

illuminance

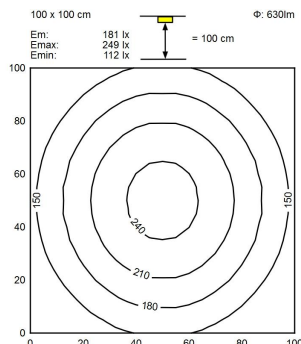

luminous intensity

