

M12-A-5

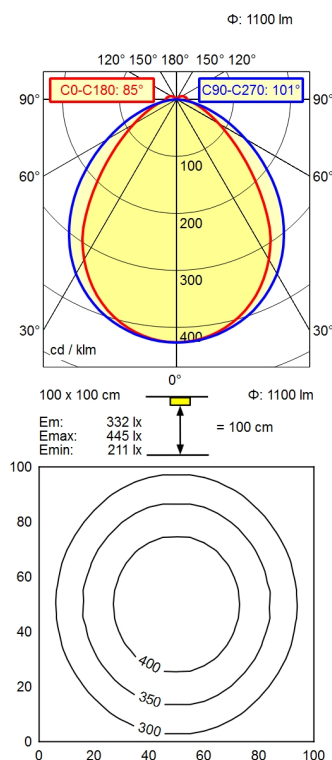

<b>Light source</b>	LED
<b>Work equipment</b>	Without
<b>Connected load</b>	22 - 26 V; DC
<b>Power consumption</b>	ca. 9 W
<b>Luminous flux</b>	approx. 1.100 lm
<b>Luminous efficiency</b>	approx. 122 lm/W
<b>Light type/-color</b>	Cold white
<b>Colour temperatur</b>	approx. 5.000 K
<b>Color rendering index</b>	CRI ≥ 80
<b>Light distribution</b>	Direct
<b>Beam angle</b>	85° / 101°
<b>Chromaticity tolerance LED</b>	< 4 SDCM
<b>Glare control</b>	Screen
<b>System of protection</b>	IP 54
<b>Class of protection</b>	III
<b>Technology</b>	Multi-stage switchable; -
<b>Operation</b>	External
<b>Housing</b>	Aluminium/plastic; Anodised, painted; Aluminium coloured anodised
<b>Light source cover</b>	Acrylic (PMMA); Satine
<b>Weight (net)</b>	ca. 0,2 kg
<b>Mains lead</b>	Built-in plug; M12-A-5
<b>Design</b>	mounted version
<b>Fastening</b>	Bracket
<b>Dimension</b>	A=335mm,Cmin=275mm,Cmax=320mm
<b>Minimum ambient temperature</b>	5 °C
<b>Maximum ambient temperature</b>	50 °C
<b>Decorative contrast side parts</b>	Natural silver anodised
<b>Special features</b>	ADVANCED package